

CLASS "A" CAR PROP
NDT TO SCALE

PROJECT NUMBER:	00-W-000	REVISION DATES
PROJECT ERECTOR:	JPK	1 1-24-13
DRAWN BY:	REP	2
REVIEWED BY:	REP	3
PRINT DATE:	12-26-12	4

CLASS "A" CAR PROP

THIS DRAWING IS THE PROPERTY OF TRAINING TOWERS, INC. AND IS TO BE USED ONLY FOR THE PROJECT AND SITE SPECIFICALLY IDENTIFIED HEREIN. IT IS TO BE KEPT IN THE OFFICE OF THE PROJECT ERECTOR AND NOT REPRODUCED OR TRANSMITTED IN ANY FORM OR BY ANY MEANS, ELECTRONIC OR MECHANICAL, INCLUDING PHOTOCOPYING, RECORDING, OR BY ANY INFORMATION STORAGE AND RETRIEVAL SYSTEM, WITHOUT THE WRITTEN PERMISSION OF TRAINING TOWERS, INC.

1ST ALARM - FOUR STORY FIRE TRAINING SIMULATOR

FIRE DEPARTMENT TRAINING SIMULATOR

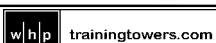

A DIV. OF J.S.C. INC

9121 BOND OVERLAND PARK, KS 66214
TEL: 913-385-3663 FAX: 913-385-7078
TOLL FREE 1-800-351-2525 www.trainingtowers.com

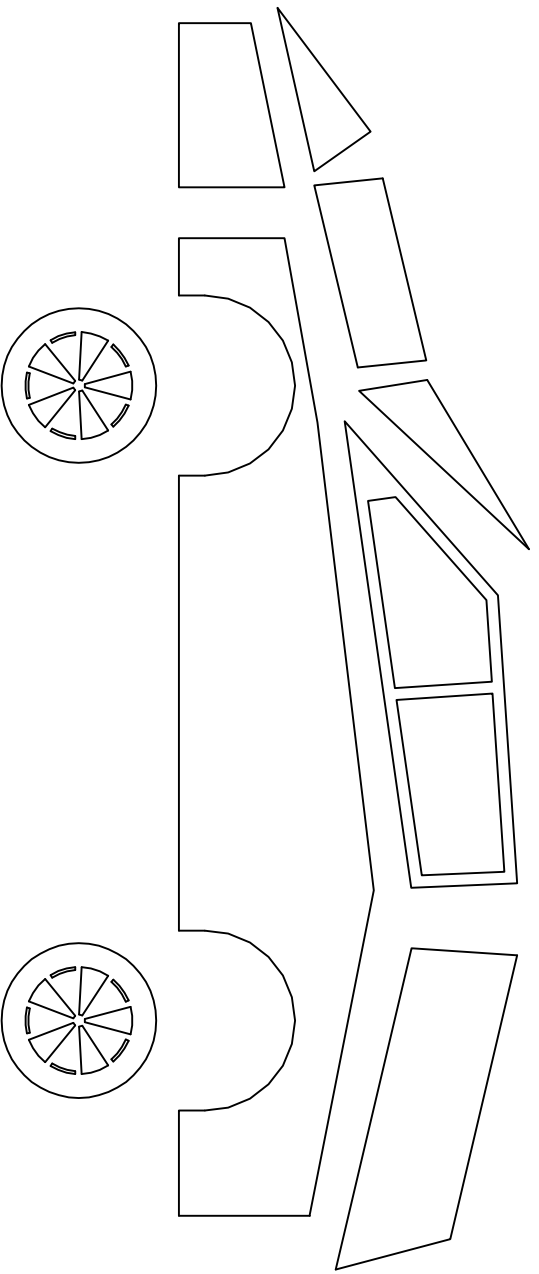
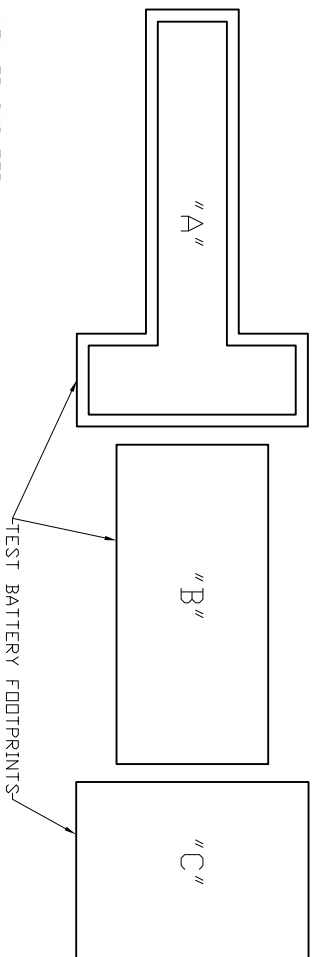
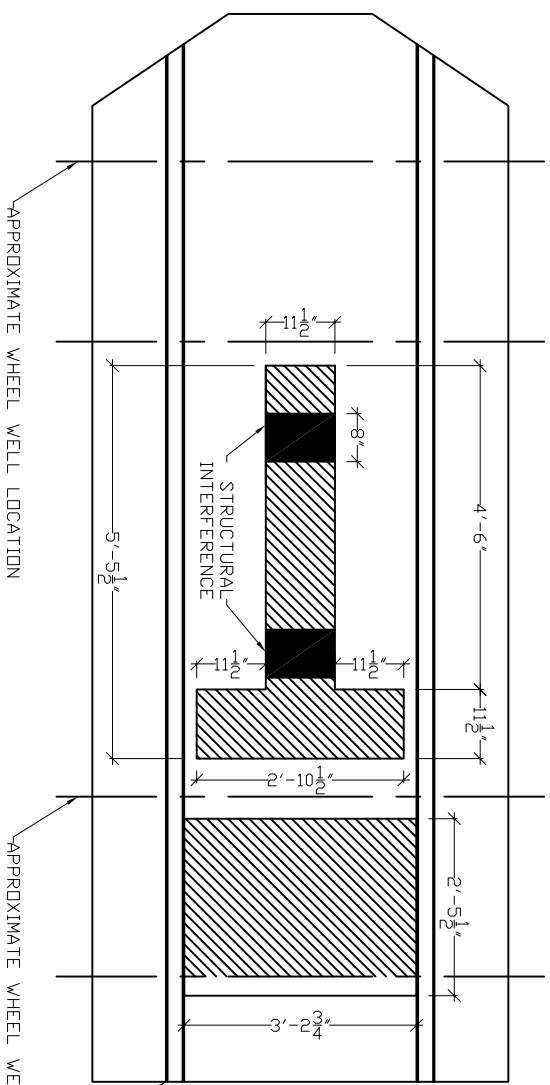
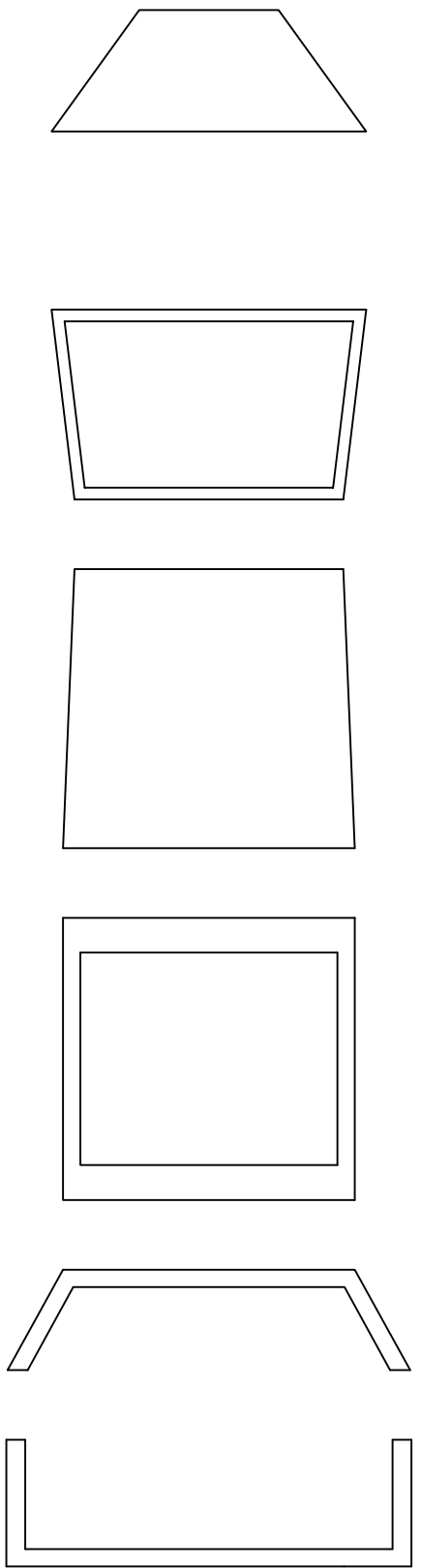

CLASS "A" CAR PROP EXPLODED PART DETAILS
NOT TO SCALE

PROJECT NUMBER:	00-W-000	REVISION DATES
PROJECT ERECTOR:		1
DRAWN BY:	JPK	2
REVIEWED BY:	REP	3
PRINT DATE:	1-24-13	4

CLASS "A" CAR PROP
EXPLODED COMPONENT DETAIL

THE INFORMATION CONTAINED ON THIS DRAWING IS THE PROPERTY OF TRAINING TOWERS, INC. AND IS TO BE USED ONLY FOR THE PROJECT AND SITE SPECIFICALLY IDENTIFIED HEREON. IT IS TO BE KEPT IN CONFIDENCE AND NOT TO BE REPRODUCED, COPIED, OR TRANSMITTED IN ANY FORM OR BY ANY MEANS, ELECTRONIC OR MECHANICAL, INCLUDING PHOTOCOPYING, RECORDING, OR BY ANY INFORMATION STORAGE AND RETRIEVAL SYSTEM, WITHOUT THE WRITTEN PERMISSION OF TRAINING TOWERS, INC. THE USER OF THIS DRAWING AGREES TO HOLD TRAINING TOWERS, INC. HARMLESS FROM AND AGAINST ALL LIABILITY, DAMAGES, LOSSES, AND EXPENSES, INCLUDING REASONABLE ATTORNEY'S FEES, THAT MAY BE INCURRED BY TRAINING TOWERS, INC. OR ITS EMPLOYEES, AGENTS, OR SUBCONTRACTORS AS A RESULT OF THE USER'S USE OF THIS DRAWING.

**1ST ALARM - FOUR STORY
FIRE TRAINING SIMULATOR**

FIRE DEPARTMENT TRAINING SIMULATOR

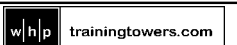

A DIV. OF J.S.C. INC

9121 BOND OVERLAND PARK, KS 66214
TEL: 913-385-3663 FAX: 913-385-7078
TOLL FREE 1-800-351-2525 www.trainingtowers.com

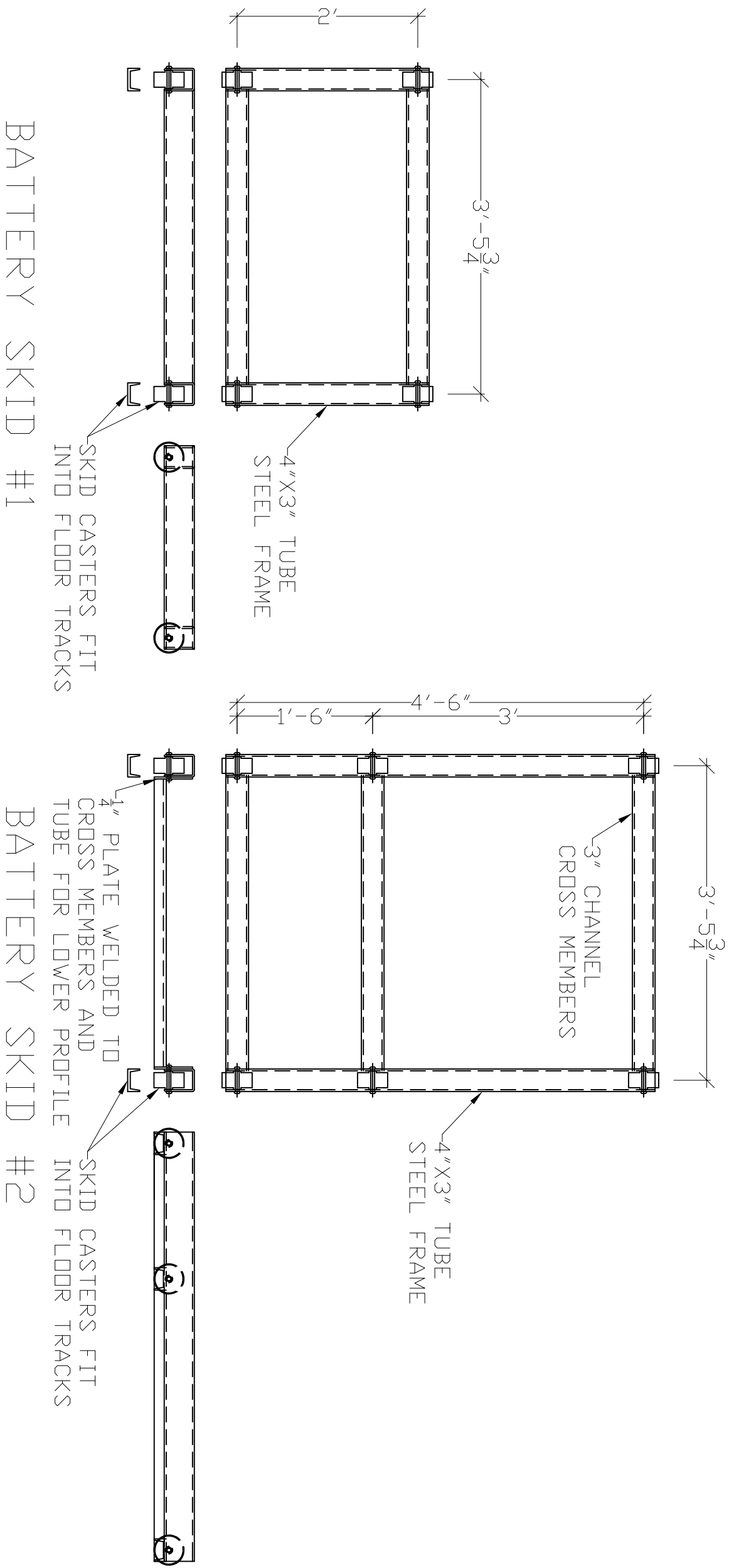

PROJECT NUMBER:	00-W-000	REVISION DATES
PROJECT ERECTOR:		1 1-24-13
DRAWN BY:	JPK	2
REVIEWED BY:	REP	3
PRINT DATE:	12-26-12	4

CLASS "A" CAR PROP

THESE DRAWINGS, SPECIFICATIONS, NOTES, SCHEDULES, AND CONDITIONS ARE THE PROPERTY OF TRAINING TOWERS, INC. AND ARE TO BE USED ONLY FOR THE PROJECT AND SITE SPECIFICALLY IDENTIFIED HEREIN. ANY REUSE, REPRODUCTION, OR MODIFICATION OF THESE DRAWINGS WITHOUT THE WRITTEN CONSENT OF TRAINING TOWERS, INC. IS STRICTLY PROHIBITED.

**1ST ALARM - FOUR STORY
FIRE TRAINING SIMULATOR**

FIRE DEPARTMENT TRAINING SIMULATOR

w|h|p trainingtowers.com

A DIV. OF J.S.C. INC

9121 BOND OVERLAND PARK, KS 66214
 TEL: 913-385-3663 FAX: 913-385-7078
 TOLL FREE 1-800-351-2525 www.trainingtowers.com