

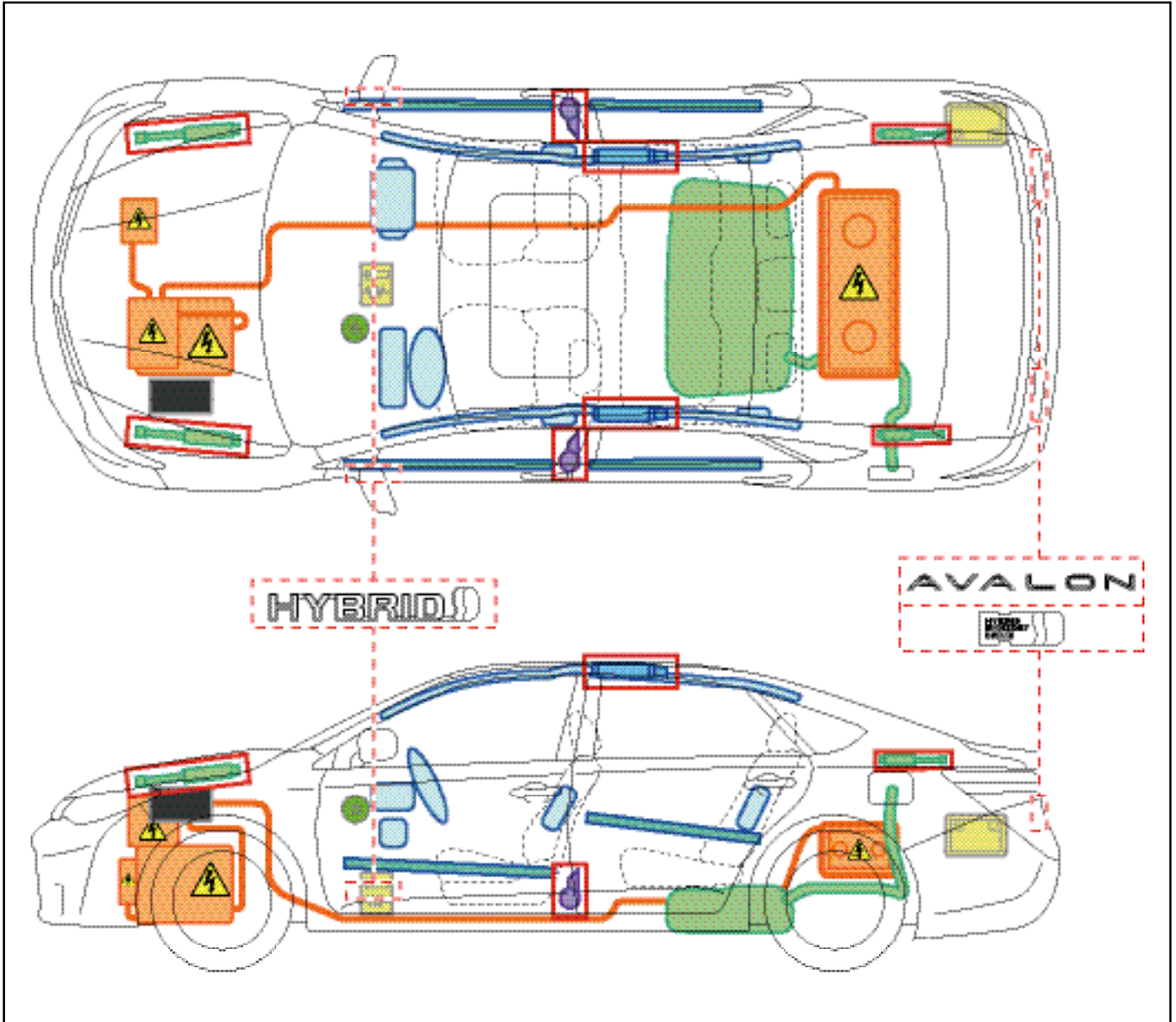

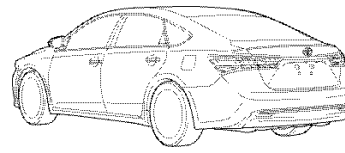

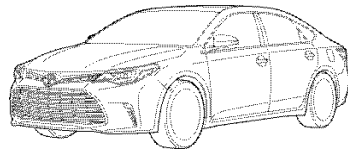





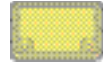

AVALON HYBRID

Emergency Response
Quick Guide

MY: 2016 -



	IG/POWER SW		Fuse Box		12V Battery
	Airbag (incl. Inflator)		Inflator		High Voltage Battery
	High Voltage Components		Fuel Tank		Gas-filled Damper
	Seat Belt Pretensioner (Gas Generator)		Structural Reinforcements		Airbag Computer
-	-	-	-	-	-

AVALONHV40_LHD_1

Disable Vehicle

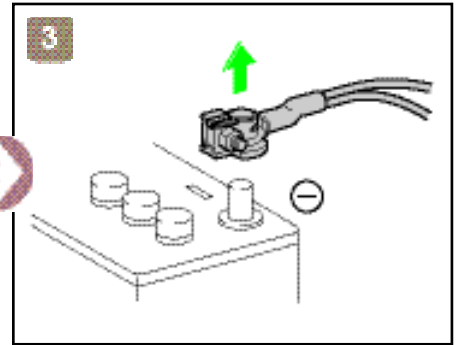

or

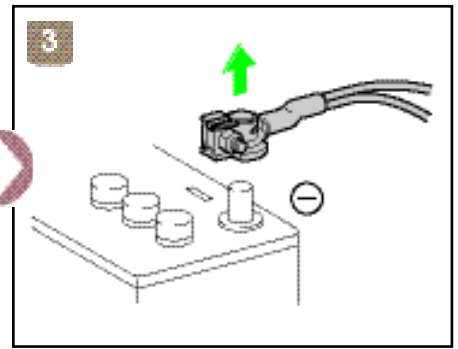
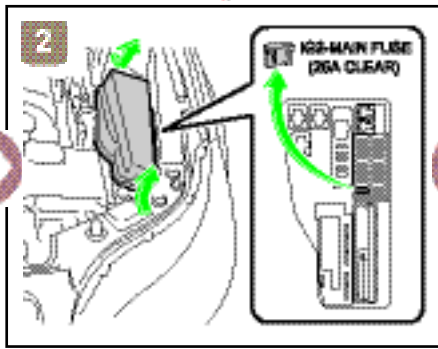
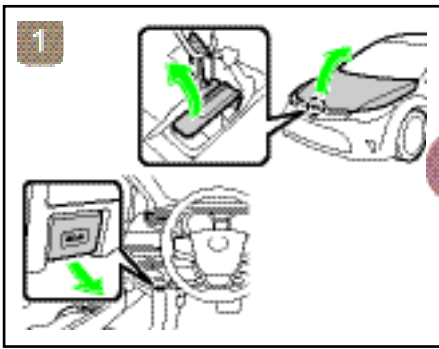

Access to 12V Battery

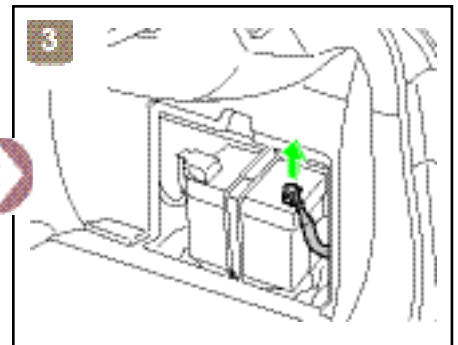
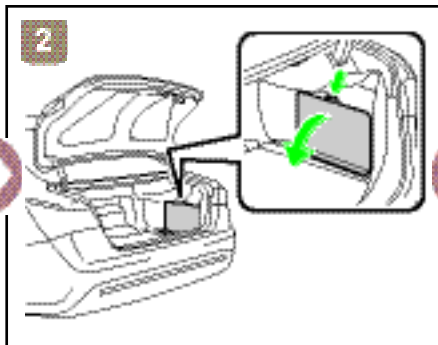
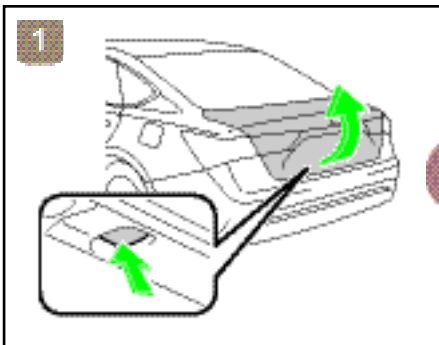

Towing Information



More details, please refer to "Emergency Response Guide."
<http://www.techinfo.toyota.com>